

DET. PUFES (30 UN.)

Pufe em couro
cores variadas

②



VISTA FRONTAL

ESC 1: 25

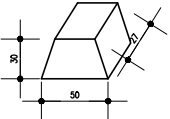

PERSPECTIVA

ESC 1: 25

Pufe couro rosa Ref. de cor HSL:
(H=14/ S=100/L=80)
Pufe couro roxo. Ref. de cor HSL:
(H=240/ S=30/L=61)
Pufe couro amarelo. Ref. de cor HSL:
(H=60/ S=85/L=74)
Pufe couro laranja. Ref. de cor HSL:
(H=30/ S=100/L=73)
Pufe couro verde. Ref. de cor HSL:
(H=120/ S=88/L=71)
OBS.: Fazer 6 unidades de cada cor

Fazer furo p/ encaixe das
letras do alfabeto

DET. Painel para fixação de atividades tipo I

⑨

Chapa ecológica
Ecopex

191

VISTA FRONTAL

ESC 1: 25

DET. Armário p/ mochilas com 30 nichos

⑥

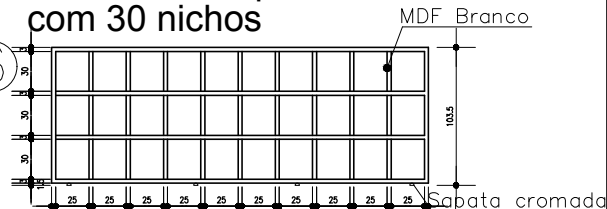

VISTA FRONTAL

ESC 1: 25

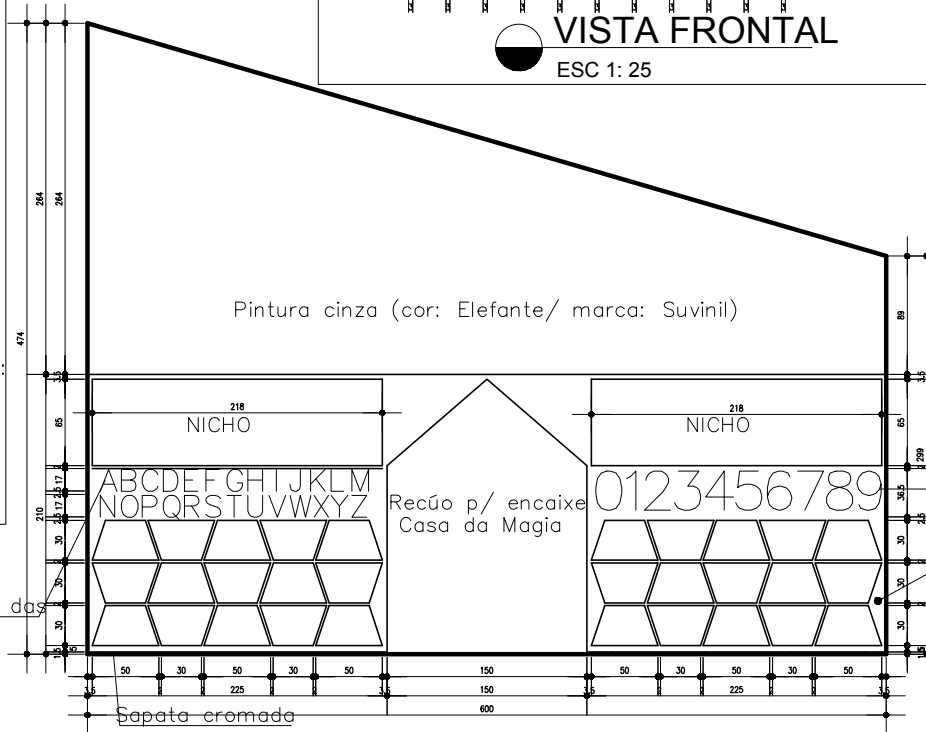

VISTA 1

ESC 1: 25

OBS.: Fazer peças de letras de 25cm de profundidade, altura de 17cm e largura de 14cm (deixar espaçamento de 2cm entre uma peça e outra)

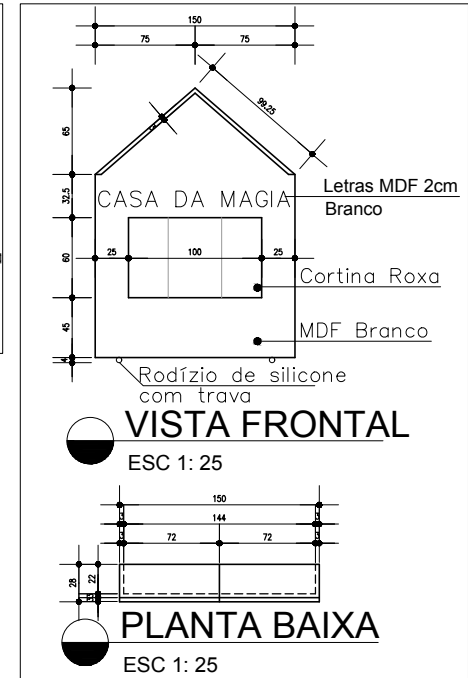

VISTA FRONTAL

ESC 1: 25

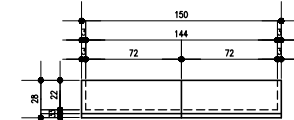

PLANTA BAIXA

ESC 1: 25

Fazer furo p/ encaixe
dos números

Chapa ecológica
Ecopex

CONTEÚDO
DETALHAMENTOS SALA INFANTIL

ESCALA
INDICADA

DESENHO
NAYARA SOUTO

FOLHA

26/44

DATA
NOV/2019

DET. Mesa trapézio várias diagramações empilhável (30 unidades)

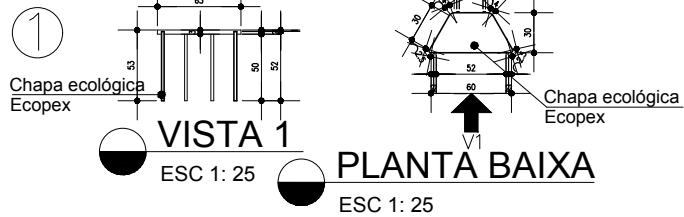

DET. Mesa hexagonal empilhável (5 unidades)

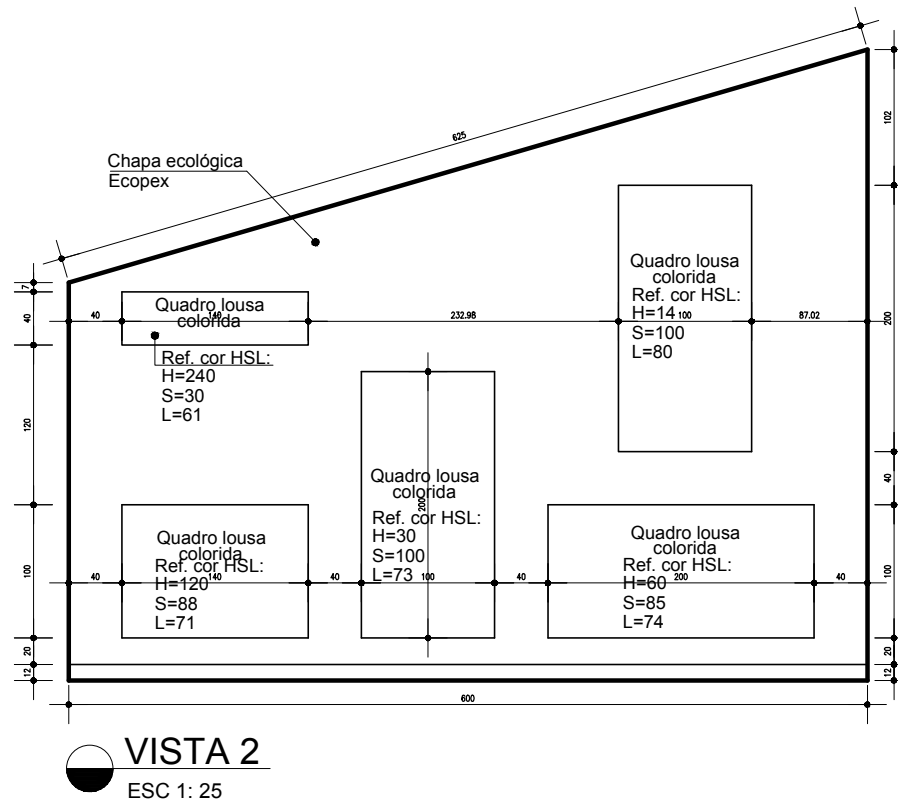
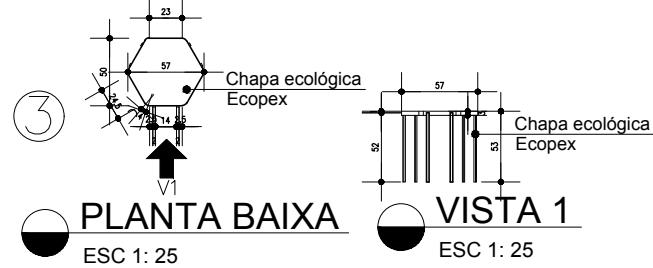

CONTEÚDO
DETALHAMENTO SALA INFANTIL

ESCALA
INDICADA

DESENHO
NAYARA SOUTO

FOLHA

27/44

DATA
NOV/2019

DET. Armário de apoio

7



ESC 1: 25

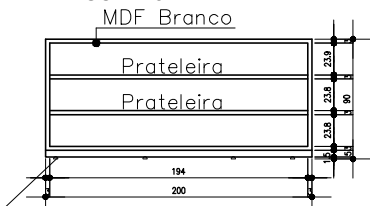

ESC 1: 25

DET. Porta livros (2 unidades)

8

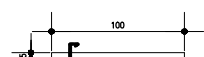

ESC 1: 25

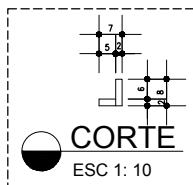

ESC 1: 10

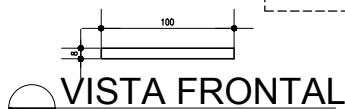

ESC 1: 25

DET. Banco/ sapateira com arara p/ fantasias de rodízio

11

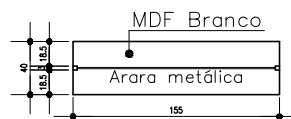

ESC 1: 25

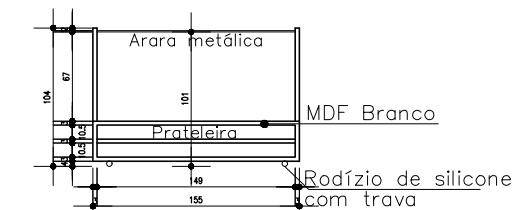

ESC 1: 25

DET. Painel para fixação de atividades tipo II (2 UN.)

10

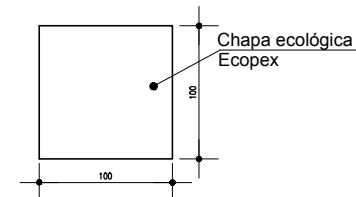

ESC 1: 25

Móvel para tatâmes e almofadas

12

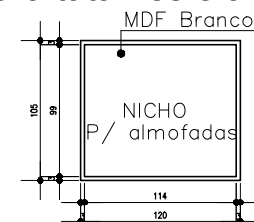

ESC 1: 25

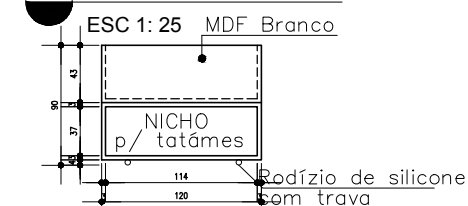

ESC 1: 25

CONTEÚDO
DETALHAMENTO SALA INFANTIL

ESCALA
INDICADA

DESENHO
NAYARA SOUTO

DATA
NOV/2019

FOLHA

28/44



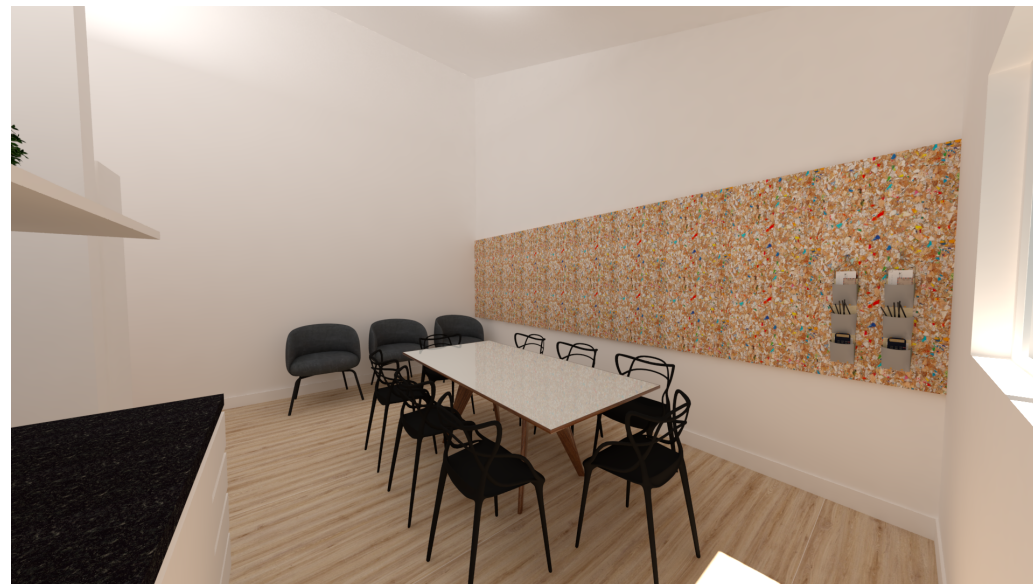

CONTEÚDO
IMAGENS SALA PROFESSORES

ESCALA
SEM ESCALA

DESENHO
NAYARA SOUTO

FOLHA
29/44

DATA
NOV/2019



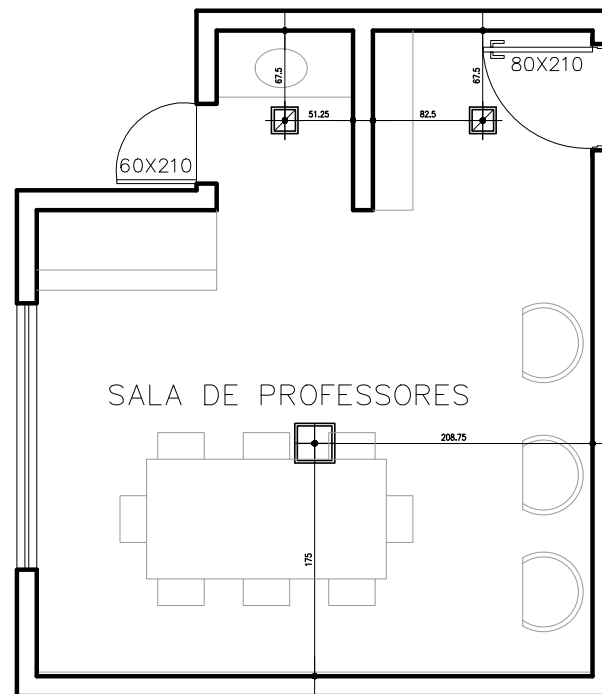
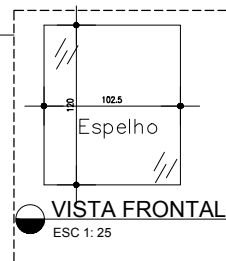
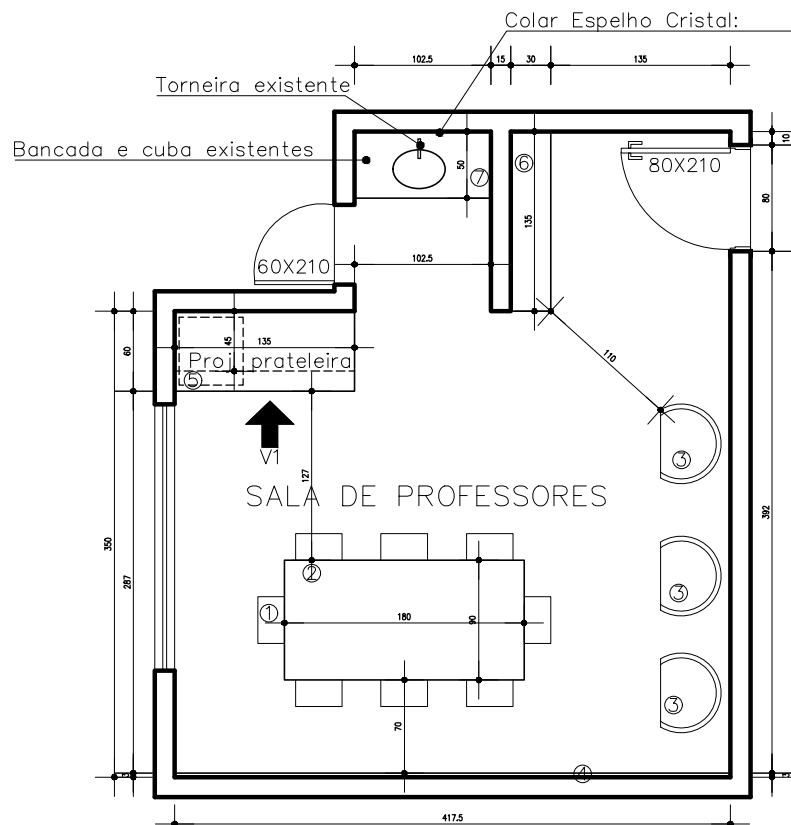

PLANTA BAIXA/ LAYOUT

ESC 1: 25

LUMINOTÉCNICO

ESC 1: 25

Legenda

① Cadeira Master Alegre Preta (8 unidades)



③ Poltrona Selena Grafite(3 unidades)



② Mesa 8 lugares Retrô- Freijo e Off White



④ Painel de avisos de chapa ecológica (Ver Detalhamento)

⑤ Bancada cozinha (Ver Detalhamento)

⑥ Armário com 15 nichos (Ver Detalhamento)

⑦ Prateleira embaixo da bancada



TABELA LUMINOTÉCNICA					
SÍMBOLO	LUMINÁRIA	QTD.	TIPO DE LÂMPADA	QTD. LÂMPADAS POR LUMINÁRIA	QTD. LÂMPADAS TOTAL
	LUMINÁRIA PLACON QUADRADO ACRÍLICO 30X30CM SOBREPOR	01	POTÊNCIA MÁX. DE CD LÂMPADA 15W Tipo de soquete E27	03	03
	LUMINÁRIA PLACON QUADRADO ACRÍLICO 30X30CM SOBREPOR	02	POTÊNCIA MÁX. DE CD LÂMPADA 15W Tipo de soquete E27	02	04

CONTEÚDO EXECUTIVO SALA PROFESSORES

ESCALA INDICADA

DESENHO NAYARA SOUTO

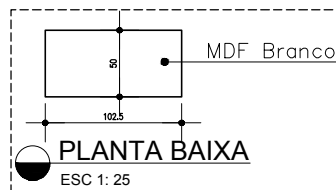
FOLHA 30/44

DATA NOV/2019

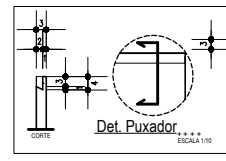
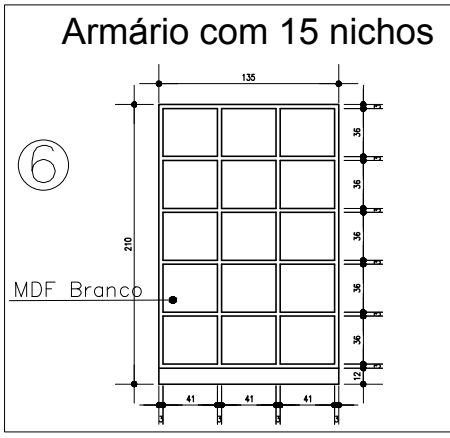
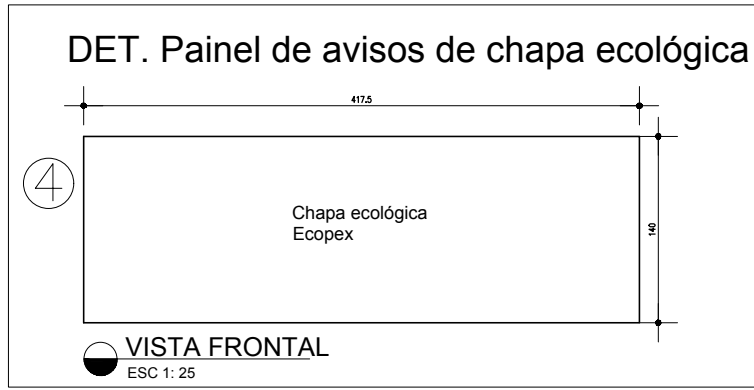

Microondas Brastemp 30L



(AxLxP): 30x53,9x42 cm

Frigobar Brastemp Retrô



(AxLxP): 80,7x48,2x5,19 cm

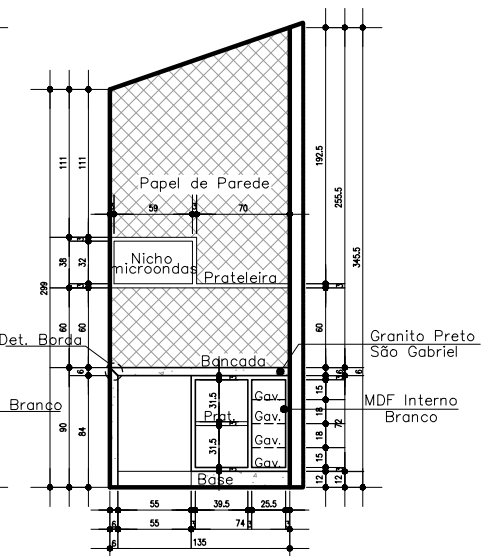
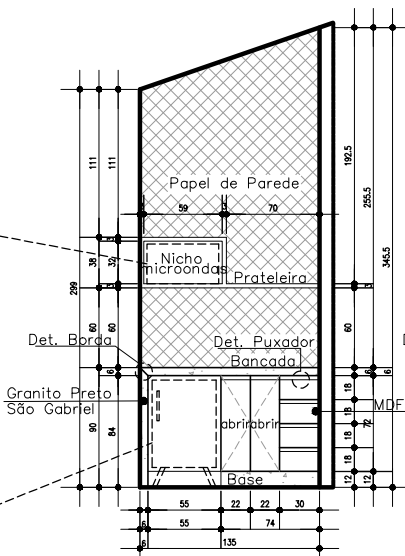

CONTEÚDO
DETALHAMENTO SALA PROFESSORES

ESCALA
INDICADA

DESENHO
NAYARA SOUTO

FOLHA
31/44
DATA
NOV/2019



CONTEÚDO
IMAGENS SALA FUNDAMENTAL

ESCALA
SEM ESCALA

DESENHO
NAYARA SOUTO



FOLHA
32/44

DATA
NOV/2019

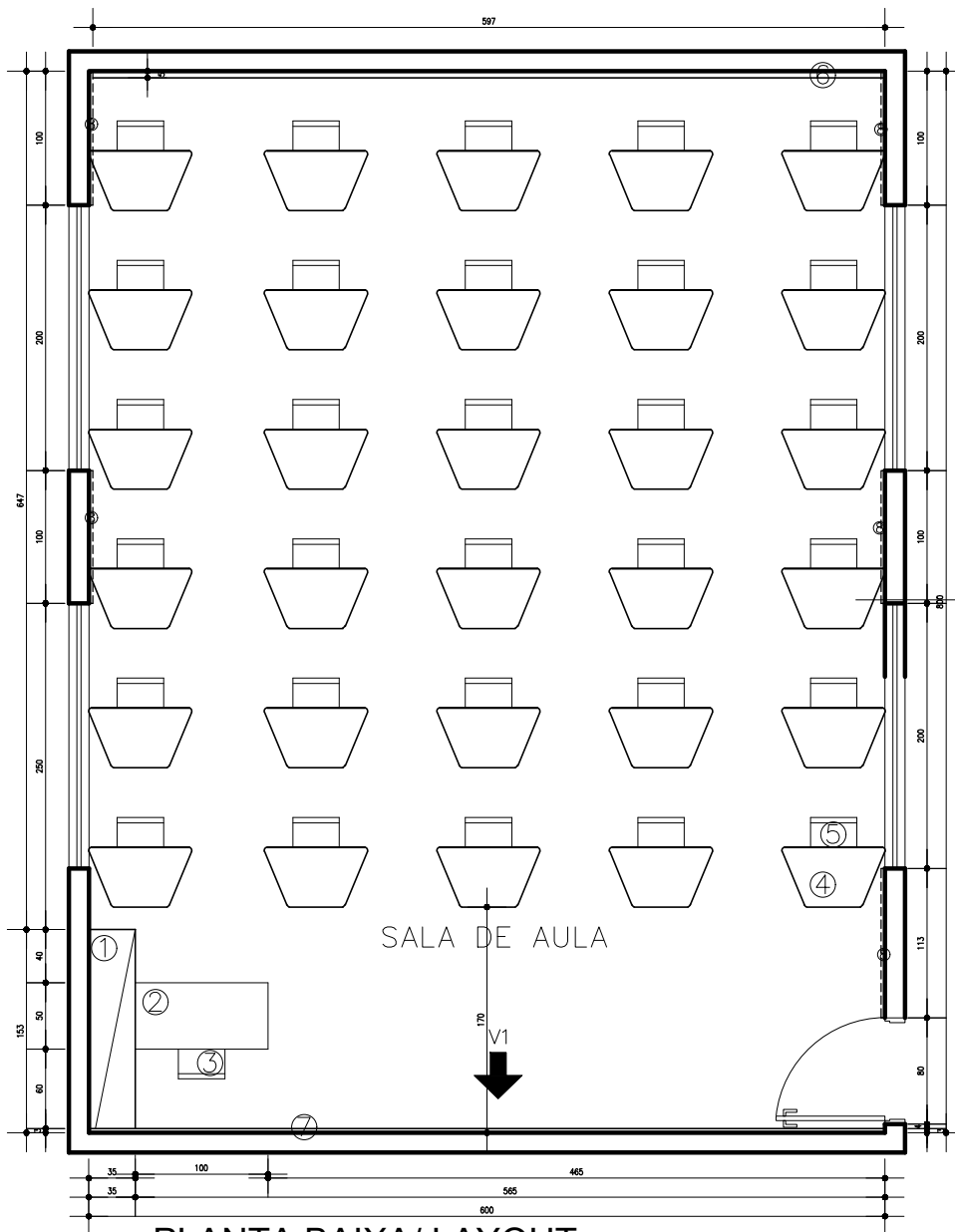

PLANTA BAIXA/ LAYOUT
ESC 1: 25

Legenda:

- ① Armário de apoio (Ver Detalhamento)
- ② Mesa professor dobrável (Ver Detalhamento do armário de apoio)
- ③ Cadeira Escolar em Polipropileno cor cinza
- ④ Mesa individual multi-formas- 30 unidades (Ver Detalhamento)
- ⑤ Cadeira Escolar em Polipropileno cor azul(30 unidades)



Assento: 40 cm L x 38 cm P
Encosto: 40 cm L x 19 cm P
Altura do chão ao assento : 42 cm
Altura total Cadeira: 72 cm

- ⑥ Prateleira livros (Ver Detalhamento)
- ⑦ Quadro (Ver Detalhamento)
- ⑧ Painel p/ fixação de tarefas e avisos (Ver Detalhamento)

DET. Mesa individual multi-formas- 30 unidades

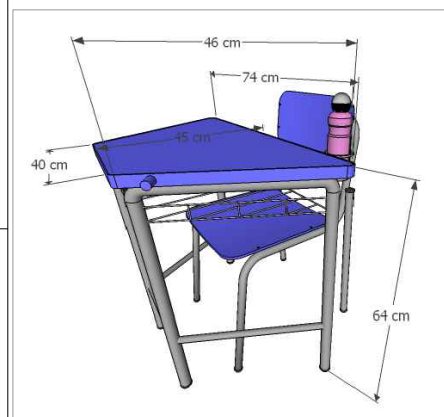

④

OBS.: Os pinos laterais das mesas têm a função de unir umas às outras para realização de trabalhos em grupo. E servem como gancho para mochila quando utilizadas individualmente.

Materiais: Tampo de polipropileno
Estrutura metálica

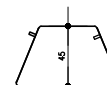
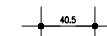

Porta garrafas
Auzan Aço Inoxidável Dobrável

Tamanho: 135x91mm/5.31x3.58

PLANTA BAIXA

ESC 1: 25



CONTEÚDO EXECUTIVO SALA FUNDAMENTAL

ESCALA INDICADA

DESENHO NAYARA SOUTO

FOLHA 33/44

DATA NOV/2019

POSSIBILIDADE DE LAYOUTS DIFERENCIADOS

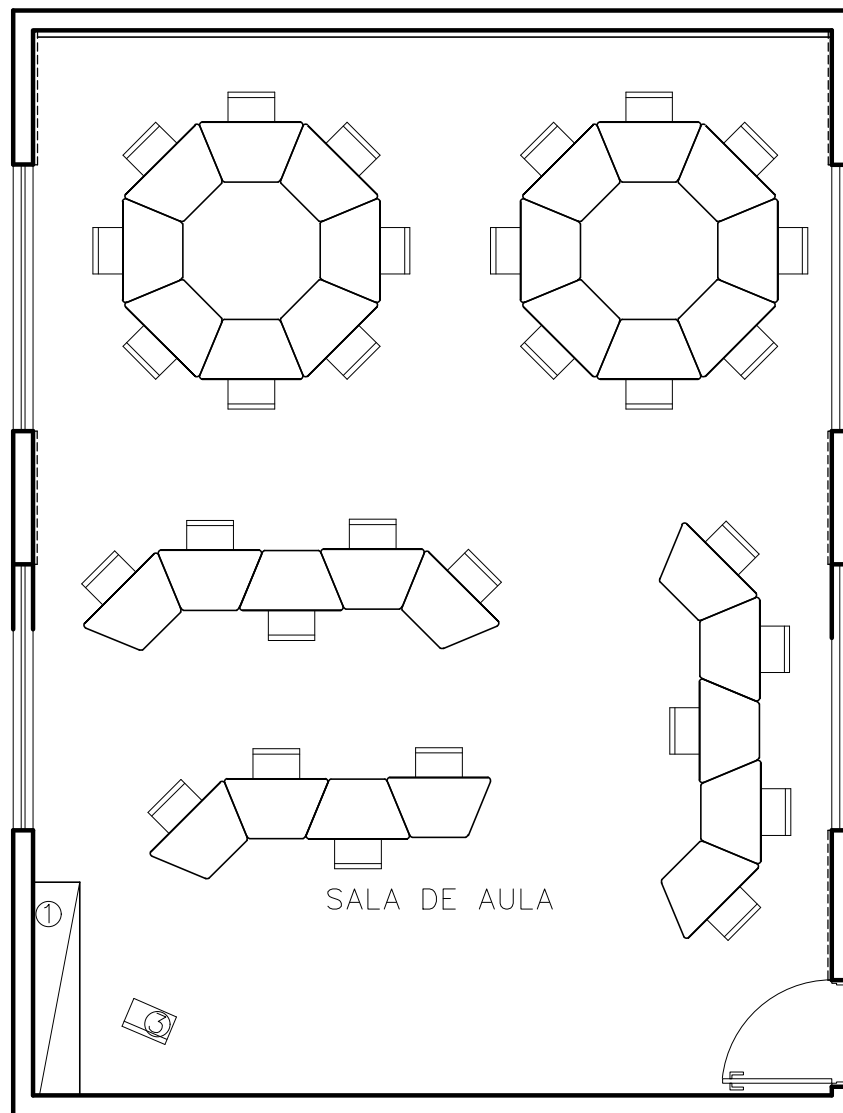

PLANTA BAIXA/ LAYOUT
 ESC 1: 25

OBS.: As mesas permitem várias organizações de layouts, possibilitando a realização de funções diversificadas para atividades desenvolvidas nesses ambientes. Para tanto foi desenvolvido um layout para melhor visualização dessas possibilidades.

DET. APOIO LIVROS

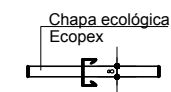
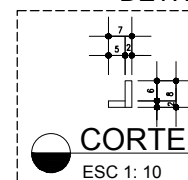

Obs.: Fazer 3 suportes de livros ao redor da sala.
 Parede esquerda: 6,5m (comprimento)
 Parede ao fundo: 5,97m (comprimento)
 Parede direita: 7,13m (comprimento)
 (Posicioná-los à 75cm do chão)

CONTEÚDO
 EXECUTIVO SALA FUNDAMENTAL

ESCALA
 INDICADA

DESENHO
 NAYARA SOUTO

FOLHA

34/44

DATA
 NOV/2019

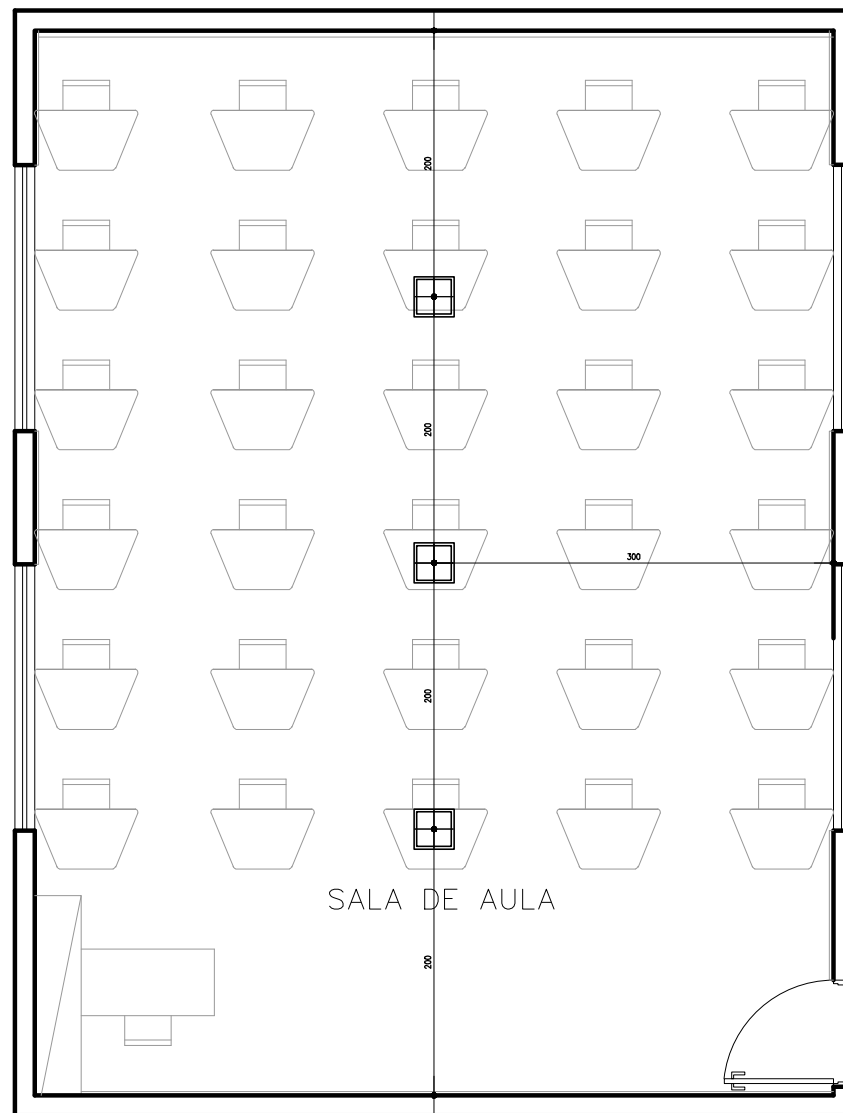

SALA DE AULA

TABELA LUMINOTÉCNICA					
SÍMBOLO	LUMINÁRIA	QTD.	TIPO DE LÂMPADA	QTD. LÂMPADAS POR LUMINÁRIA	QTD. LÂMPADAS TOTAL
	LUMINÁRIA PLAFON QUADRADO ACRÍLICO 30X30X115 SOBREFIXO	03	POTÊNCIA MÁX. DE CD LÂMPADA 8W Tipo de soquete E-27	03	09



LUMINOTÉCNICO

ESC 1: 25

CONTEÚDO EXECUTIVO SALA FUNDAMENTAL

ESCALA 1:25

DESENHO NAYARA SOUTO

FOLHA

35/44

DATA NOV/2019

